

Introducing I/O

Mike Spivey
Hilary Term 2022



UNIVERSITY OF
OXFORD

Department of
**COMPUTER
SCIENCE**

[8.1] Basics of LEDs

Forward and reverse bias

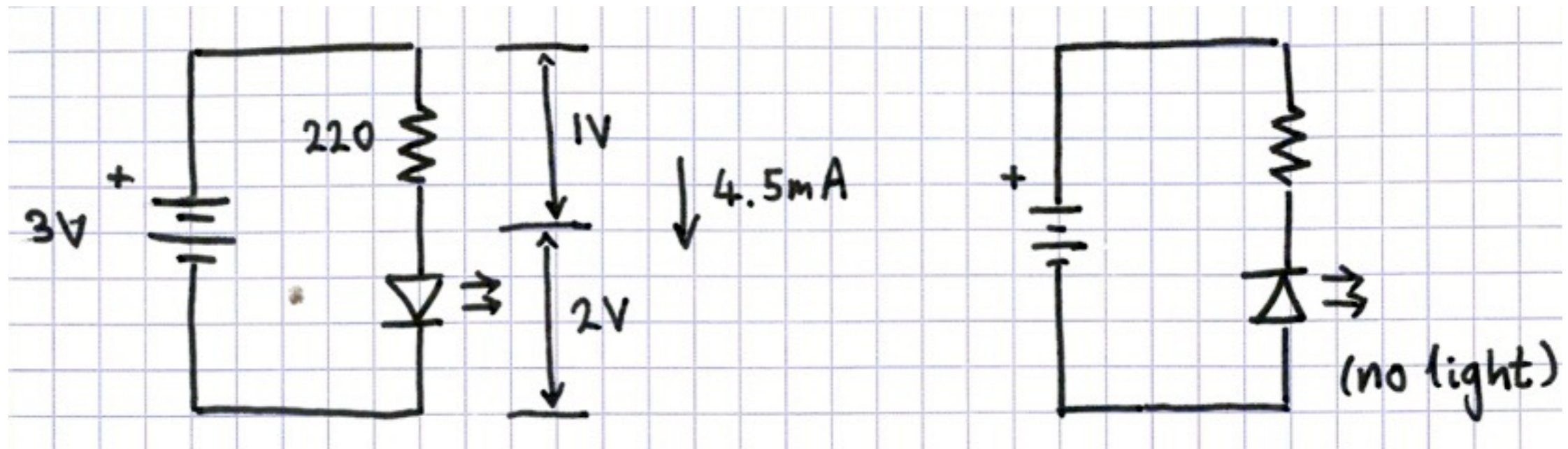

$$I = 1V / 220\Omega = 4.5mA$$

[8.2] LED multiplexing

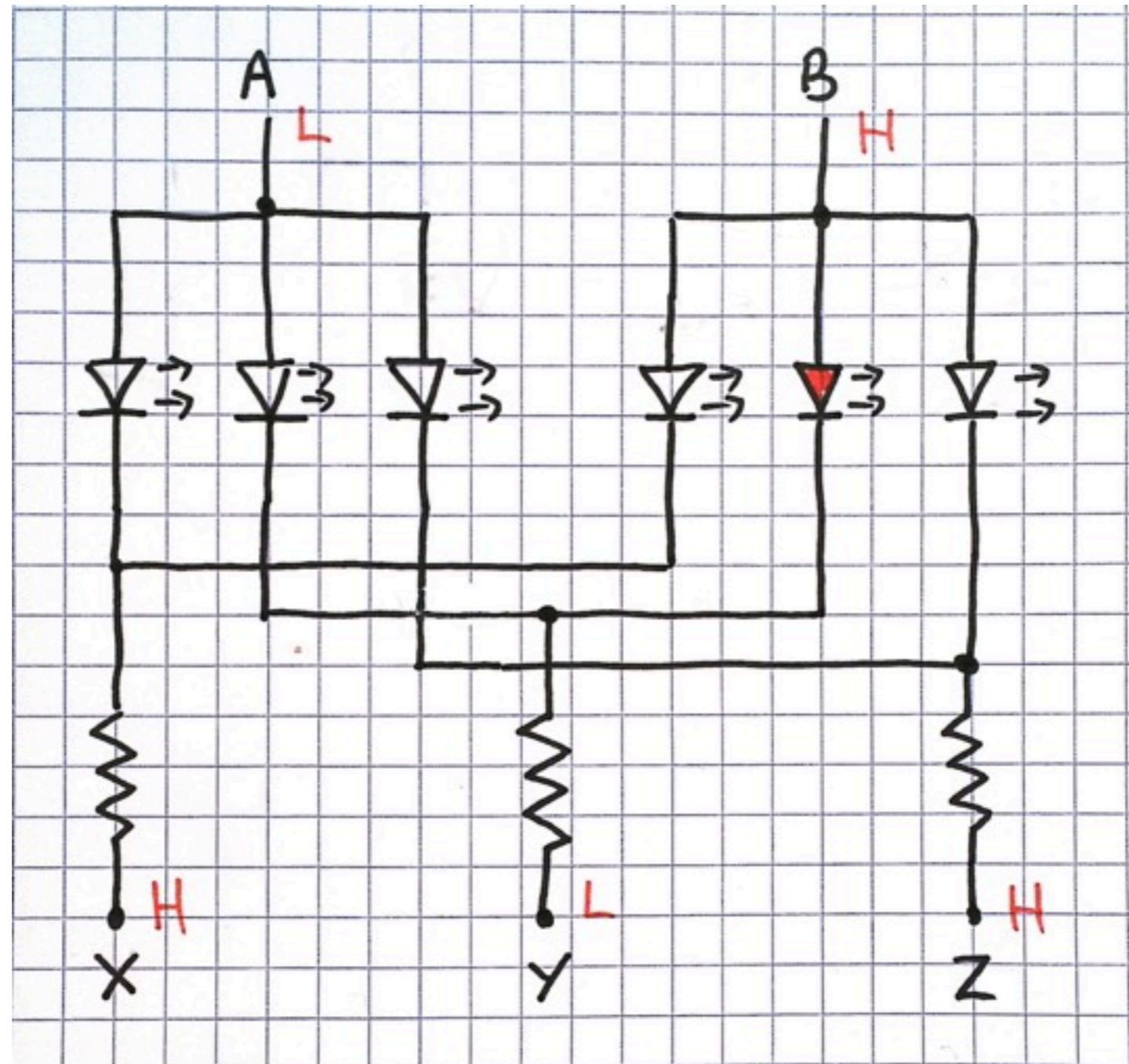

[8.3] LEDs on the micro:bit

- Physically: 5×5
- Electrically: 3×9 (with 2 gaps)
- Uses 12 bits of GPIO
- Two *active-low* pushbuttons use 2 more GPIO bits
- Two *active-low* pushbuttons use 2 more GPIO bits

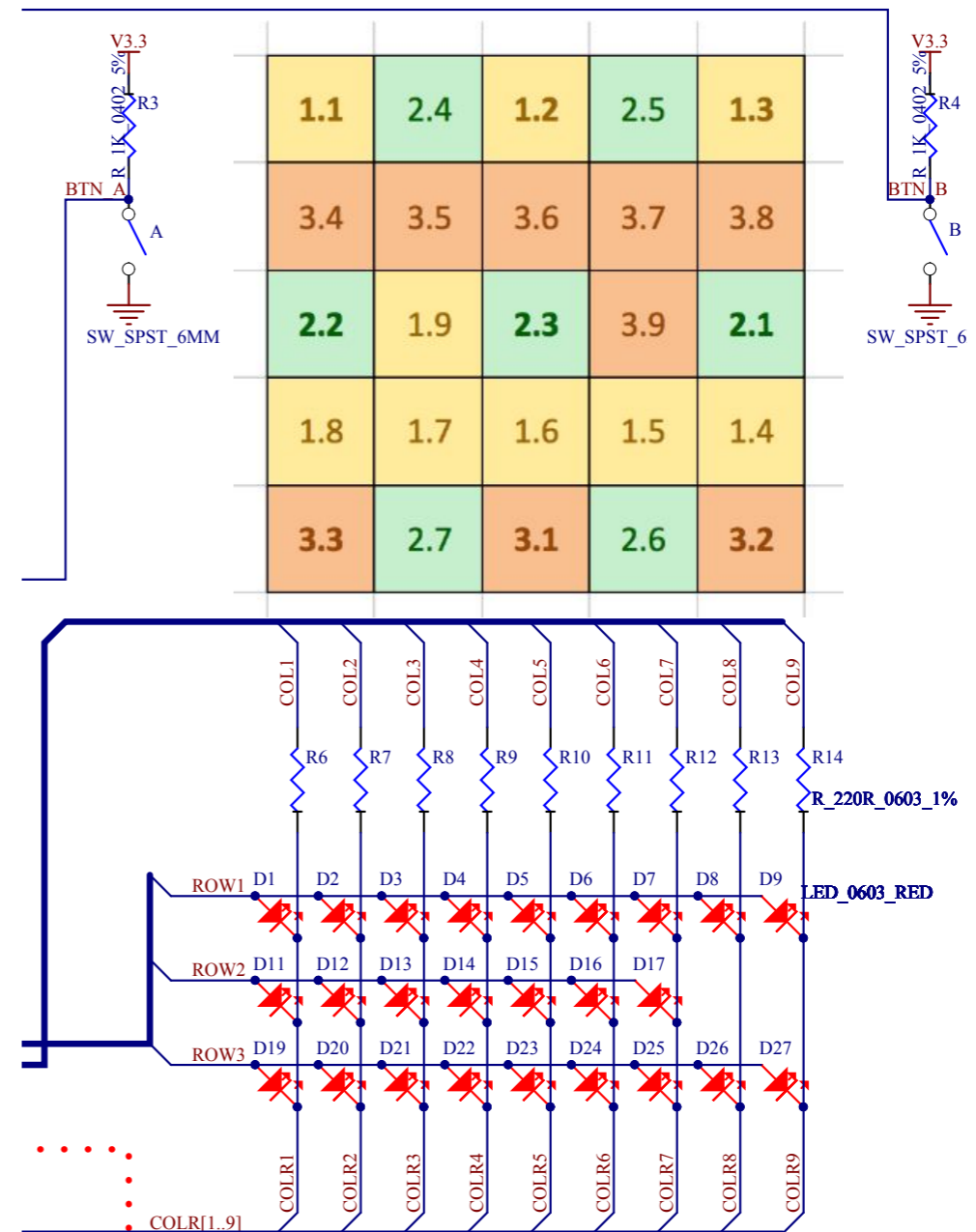

[8.4] I/O registers

GPIO.DIR	0x50000514	Controls in/out direction
GPIO.OUT	0x50000504	High or low for each pin

For example:

```
ldr r0, =0x50000504
ldr r1, =0x5fb0
str r1, [r0]
```

or in C:

```
#include "hardware.h"
...
GPIO.OUT = 0x5fb0
```

[8.5] Multiplexing the display

A pattern like this can be obtained by lighting *successively* ...

LEDs 5, 6, 7, 9 in row 1;
LEDs 1, 2, 3, 4, 5 in row 2;
LEDs 1, 4, 5, 6, 7, 8, 9 in row 3.

```
0010 1000 1111 0000 = 0x28f0
0101 1110 0000 0000 = 0x5e00
1000 0000 0110 0000 = 0x8060
```

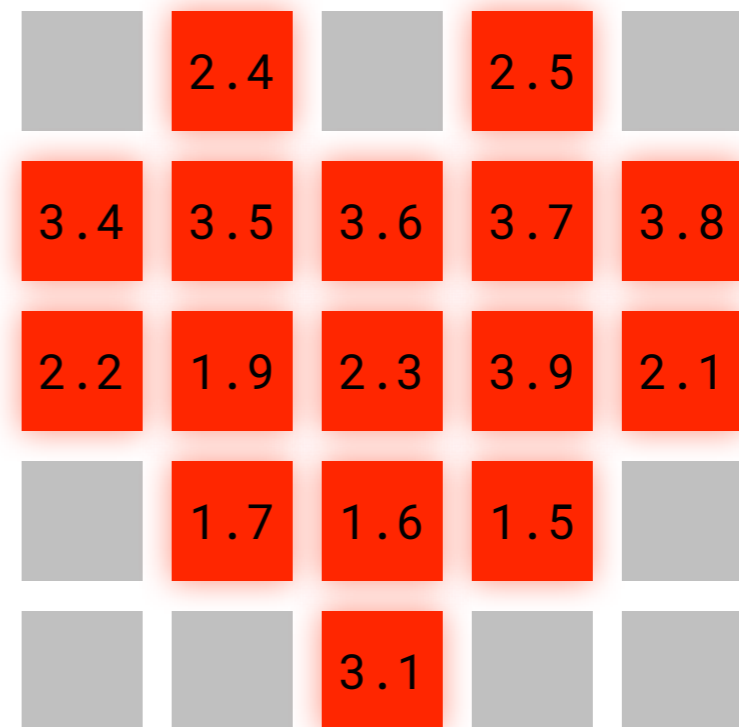

[8.6] Code for multiplexing

```
while (1) {  
    GPIO.OUT = 0x28f0;  
    delay(JIFFY);  
    GPIO.OUT = 0x5e00;  
    delay(JIFFY);  
    GPIO.OUT = 0x8060;  
    delay(JIFFY);  
}
```

Use say JIFFY = 5000 for 67 updates/sec.

[8.7] Better: make it data-driven

```
static const unsigned heart[] = {
    0x28f0, 0x5e00, 0x8060
}

/* frame -- show three rows n times */
void frame(const unsigned *img, int n) {
    while (n > 0) {
        for (int p = 0; p < 3; p++) {
            GPIO.OUT = img[p];
            delay(JIFFY);
        }
        n--;
    }
}
```

On micro:bit V2

Five rows of five instead of three rows of nine.

But the 10 GPIO bits are spread over two registers, `GPIO.OUT0` and `GPIO.OUT1`.

(The code you need is in the lab materials.)

On V1:



On V2:

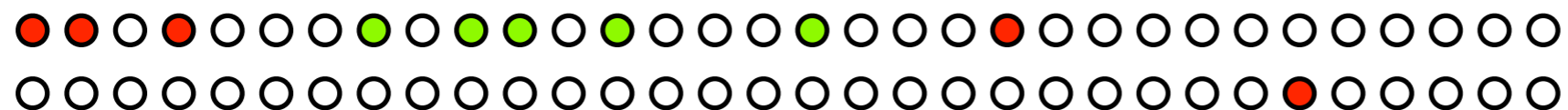

[8.8] Implementing delay()

```
void delay(unsigned usec) {  
    unsigned n = 2 * usec;  
    while (n > 0) {  
        nop(); nop(); nop();  
        n--;  
    }  
}
```

- Experiment shows that each iteration takes 8 cycles = $0.5\mu\text{s}$ at 16MHz.
- Different numbers needed on V2 at 64MHz.

Serial I/O

Mike Spivey
Hilary Term 2022



UNIVERSITY OF
OXFORD

Department of
**COMPUTER
SCIENCE**

[9.1] One character on the serial port

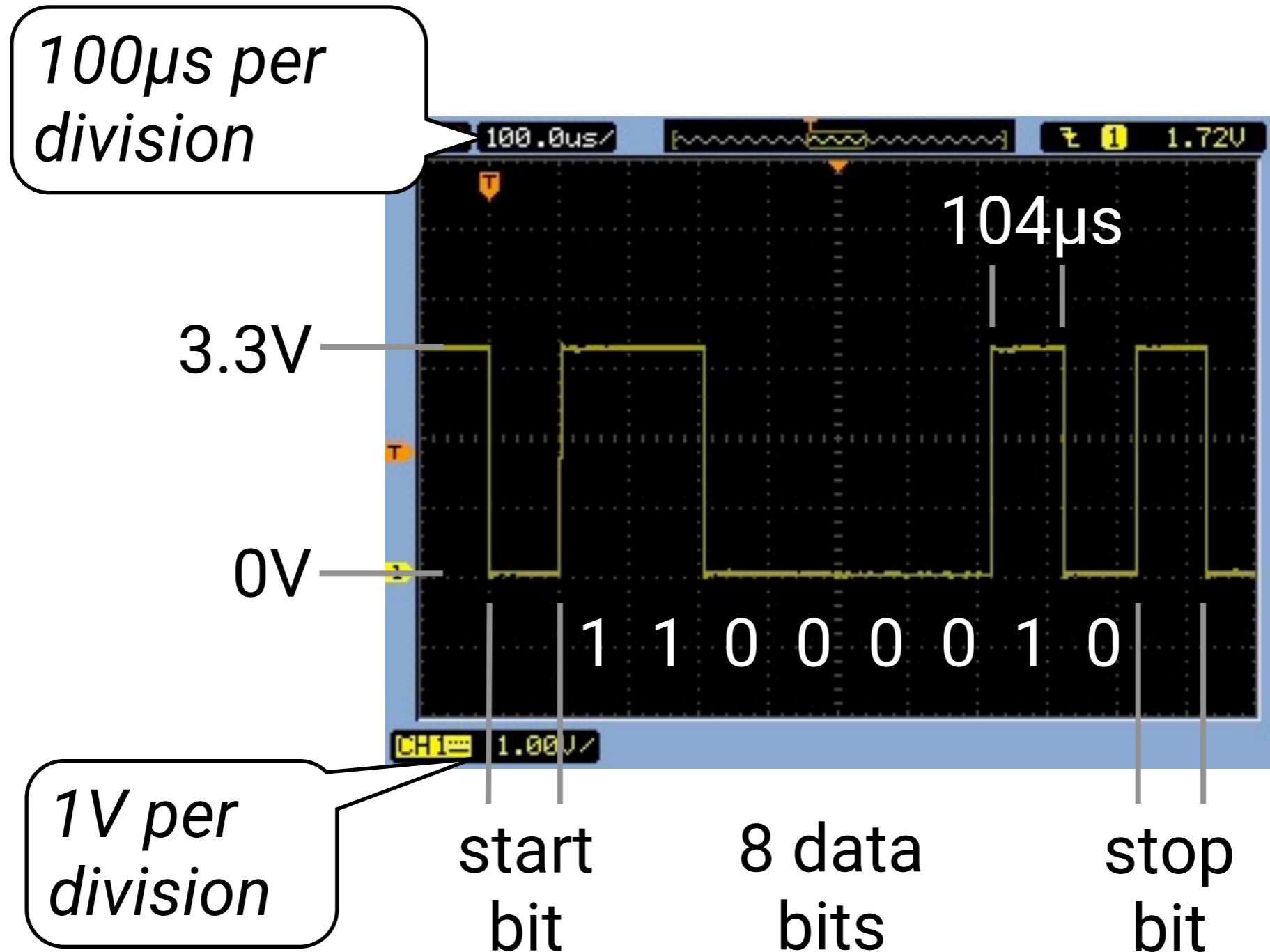

[9.1] One character on the serial port

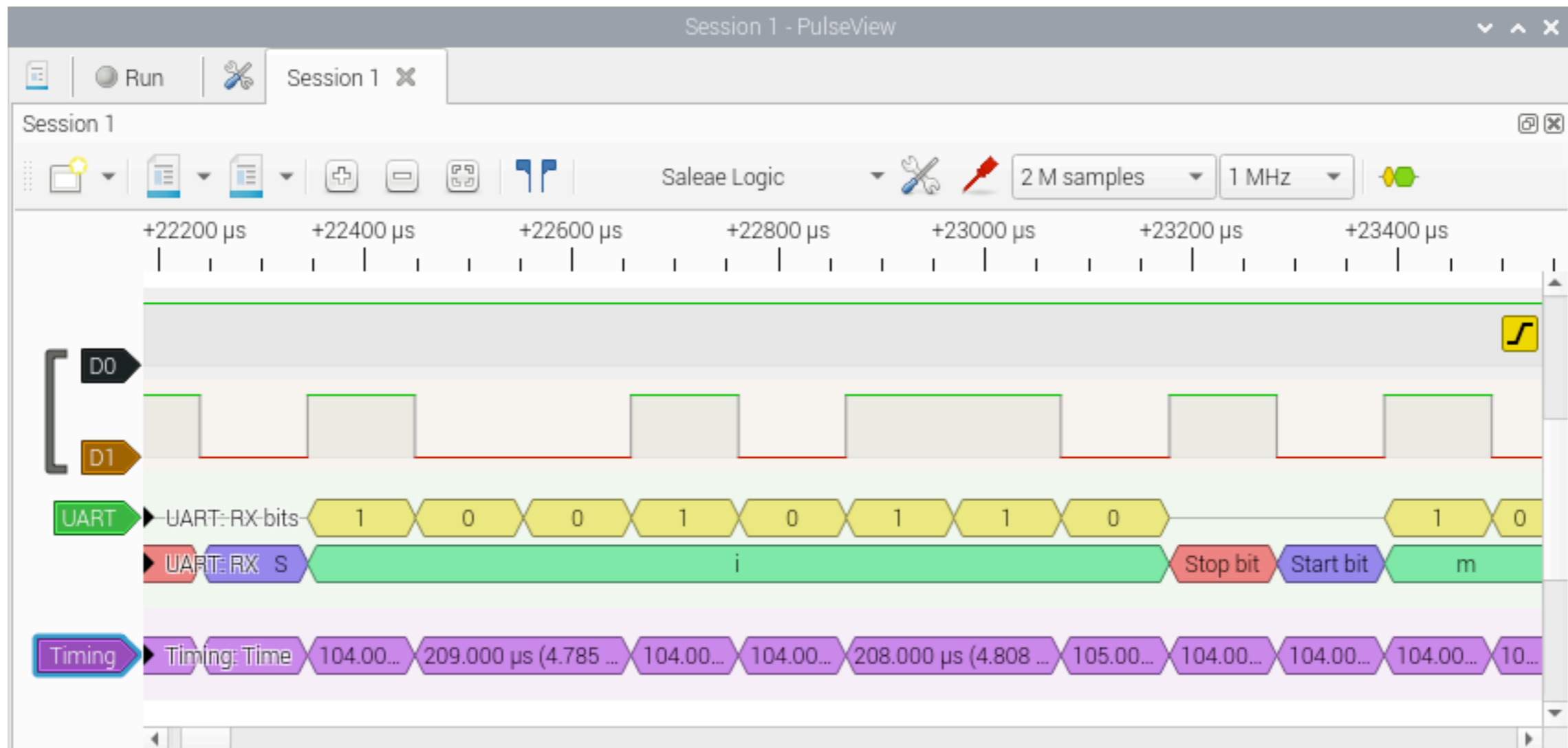

[9.2] A basic UART driver

```
void serial_putc(char ch) {
    while (! UART.TXDRDY) { /* idle */ }
    UART.TXDRDY = 0;
    UART.TXD = ch;
}
```

- This uses *polling* to wait for the previous character to finish transmitting.
- `serial_printf` is a wrapper around this

(Detail for first character omitted.)

[9.3] Testing the driver

```
start_timer();
while (count < 500) {
    if (prime(n)) {
        count++;
        serial_printf("prime(%d) = %d\r\n",
                      count, n);
    }
    n++;
}
stop_timer();
```



[9.4] Setting things up

```
void serial_init(void) {
    UART.ENABLE = 0;
    UART.BAUDRATE = UART_BAUD_9600;           // 9600 baud
    UART.CONFIG = UART_CONFIG_8N1;           // format 8N1
    UART.PSELTXD = USB_TX;                    // choose pins
    UART.PSELRXD = USB_RX;
    UART.ENABLE = UART_Enabled;
    UART.RXDRDY = 0; UART.TXDRDY = 0;
    UART.STARTTX = 1; UART.STARTRX = 1;
    txinit = 1;
}
```

[9.5] Connecting a logic analyser

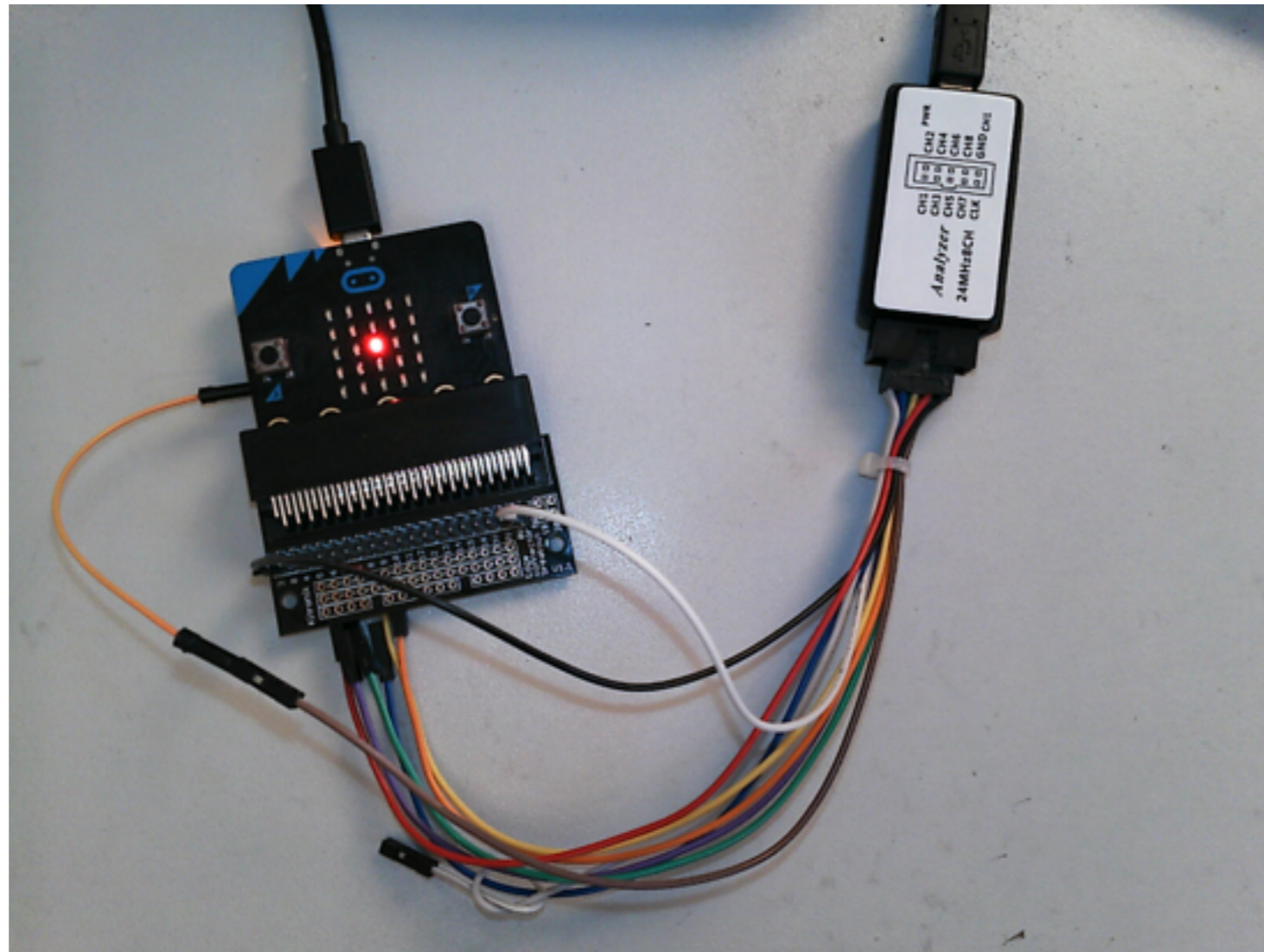

Monitoring both an LED pin and the UART

[9.6] The program starts



[9.6] Later in the run

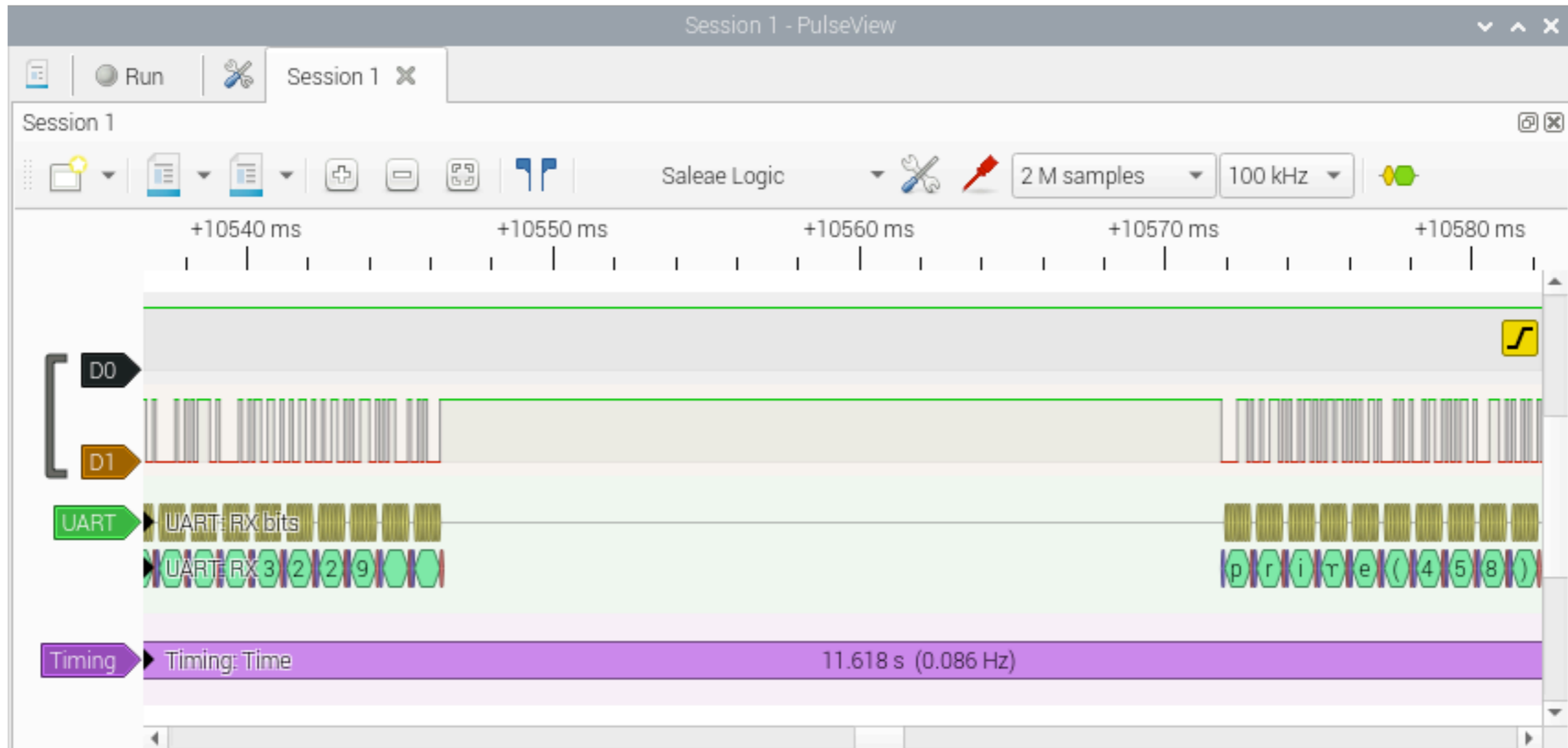

Programming with interrupts

Mike Spivey
Hilary Term 2022



UNIVERSITY OF
OXFORD

Department of
COMPUTER
SCIENCE

[10.1] Without interrupts

```
int prime(int n) {
    int k = 2;

    while (k * k <= n) {
        if (n % k == 0) return 0;
        poll_uart();
        k++;
    }

    return 1;
}
```

```
void poll_uart(void) {
    if (UART.TXDRDY) {
        // send another char
    }
}
```



[10.2] Using interrupts

```
int prime(int n) {
    int k = 2;

    while (k * k <= n) {
        if (n % k == 0) return 0;
        poll_uart();
        k++;
    }

    return 1;
}
```

```
void uart_handler(void) {
    if (UART.TXDRDY) {
        // send another char
    }
}
```

[10.3] A circular buffer

```
#define NBUF 64

static volatile int bufcnt = 0;
static int bufin = 0;
static int bufout = 0;
static volatile char txbuf[NBUF];

static volatile int txidle;
```



[10.4] Wrapping around

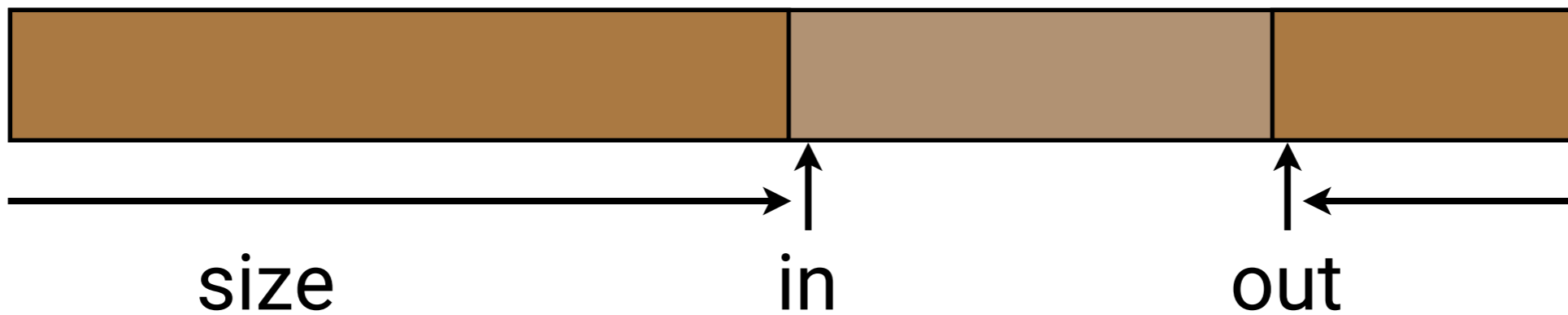
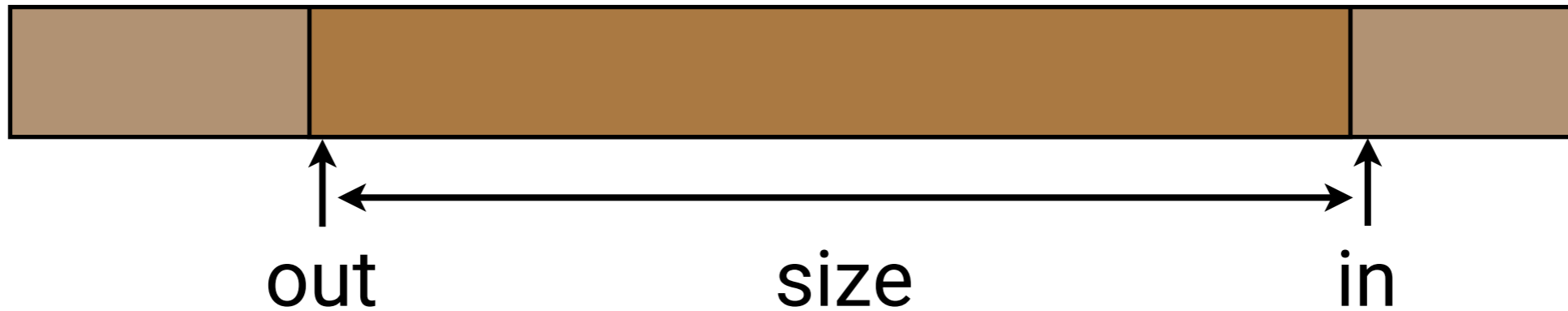

[10.5] The interrupt handler

```
void uart_handler(void) {
    if (UART.TXDRDY) {
        UART.TXDRDY = 0;
        if (bufcnt == 0)
            txidle = 1;
        else {
            UART.TXD = txbuf[bufout];
            bufcnt--;
            bufout = (bufout+1) % NBUF;
        }
    }
}
```

[10.6] Rewriting serial_putc

```
void serial_putc(char ch) {
    while (bufcnt == NBUF) pause();

    intr_disable();
    if (txidle) {
        UART.TXD = ch;
        txidle = 0;
    } else {
        txbuf[bufin] = ch; bufcnt++;
        bufin = (bufin+1) % NBUF;
    }
    intr_enable();
}
```

[10.7] Why disable interrupts?

The compiler will implement `bufcnt++` with

```
ldr r0, =bufcnt
ldr r1, [r0]
add r1, r1, #1
str r1, [r0]
```

What if an interrupt arrives here?



[10.8] Setting up the interrupt

```
void serial_init(void) {  
    ...  
  
    UART.INTENSET = BIT(UART_INT_TXDRDY);  
    enable_irq(UART_IRQ);  
    txidle = 1;  
}
```

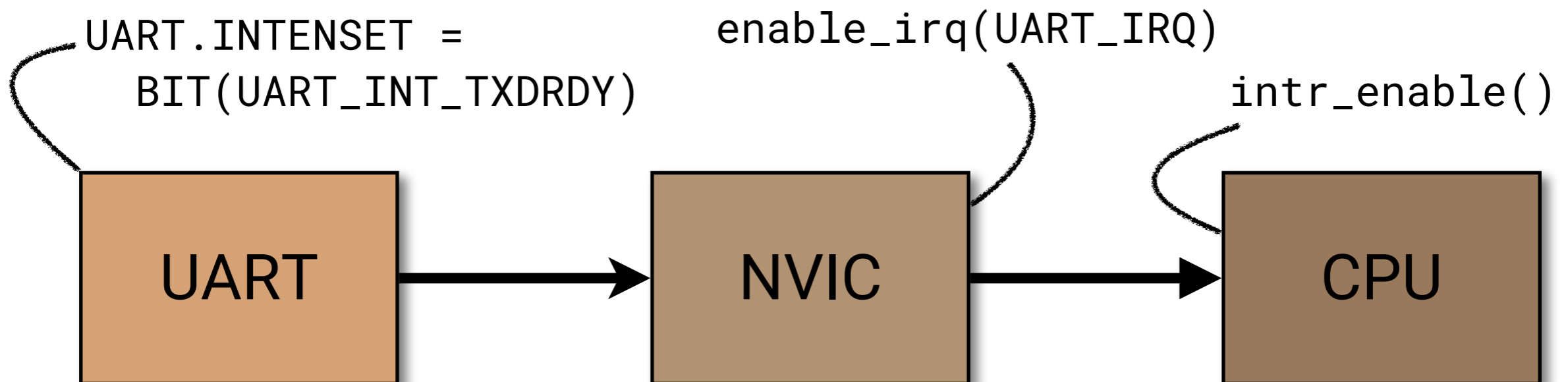

[10.9] Updated results: starting up

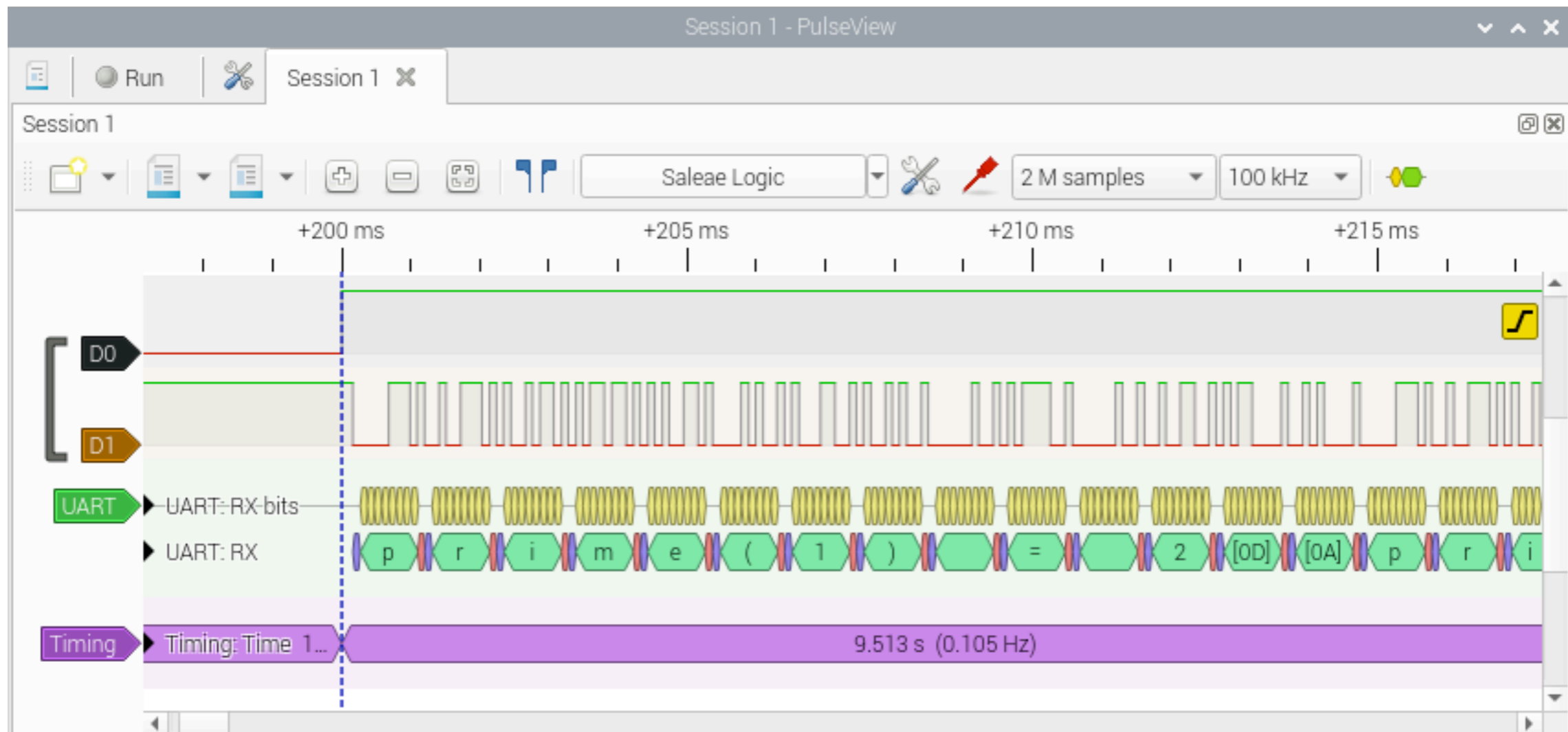

[10.9] Later in the run

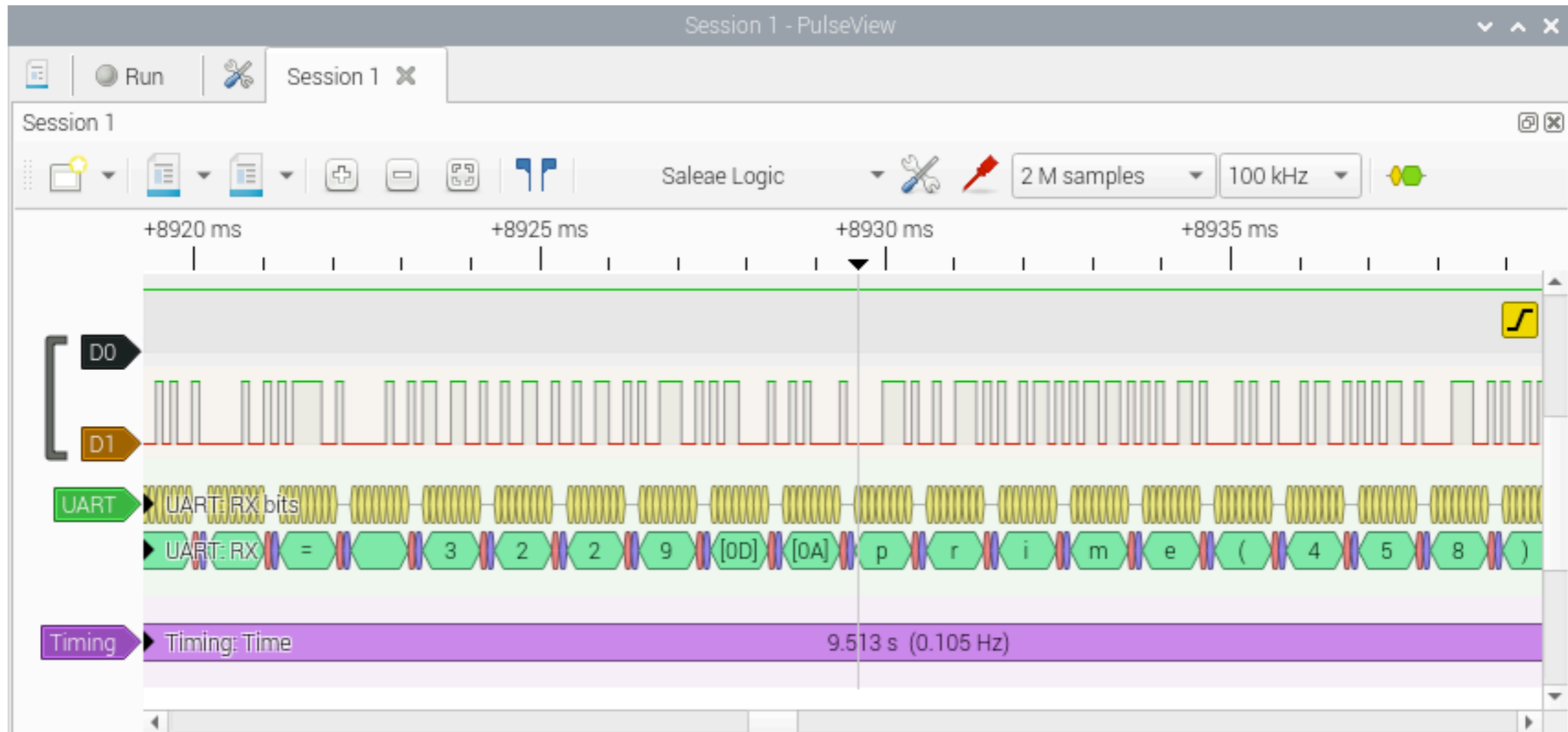

[10.10] And a surprise at the end

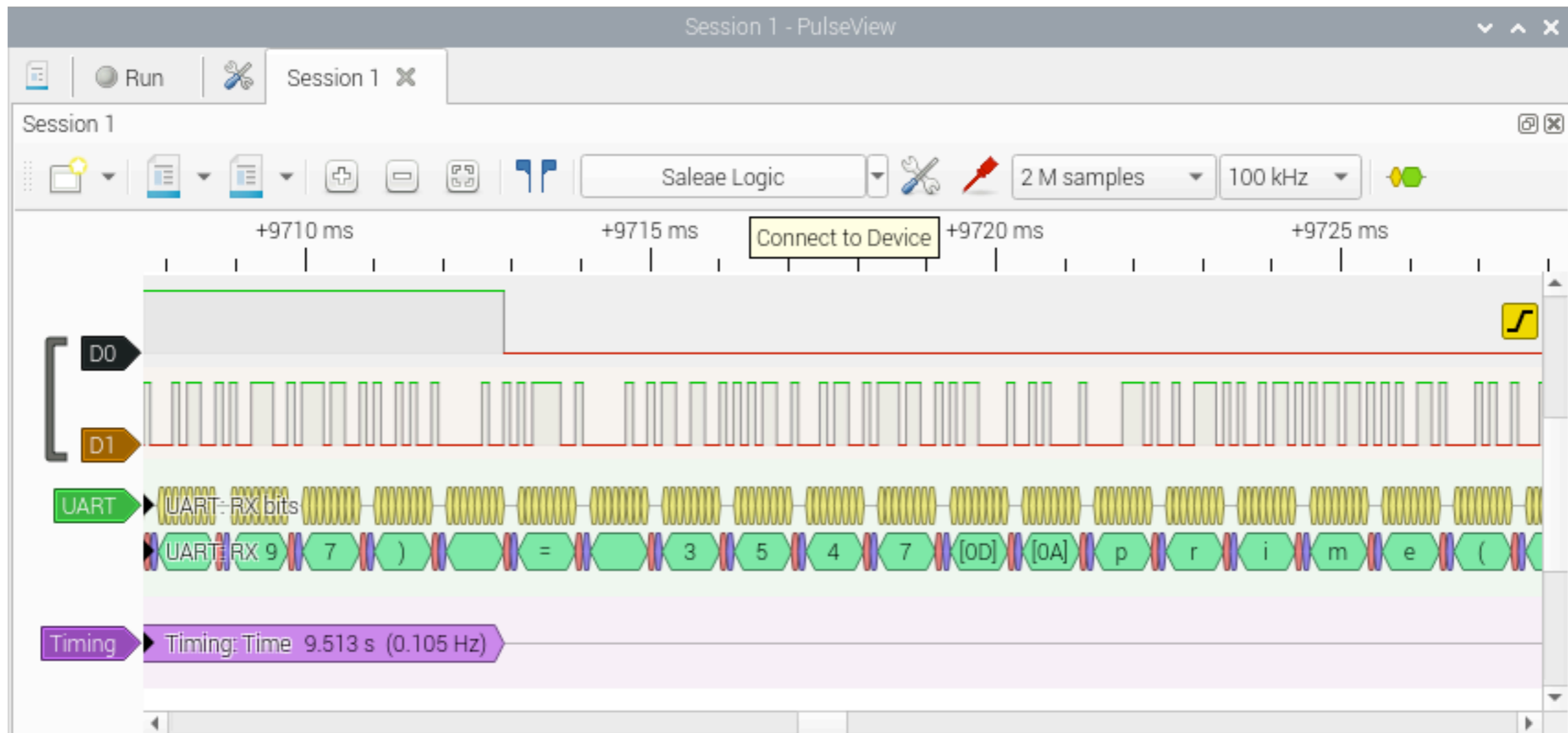

The interrupt mechanism

Mike Spivey
Hilary Term 2022



UNIVERSITY OF
OXFORD

Department of
COMPUTER
SCIENCE

[11.1] Interrupt mechanism

```
int prime(int n) {  
    int k = 2;  
  
    while (k * k <= n) {  
        if (n % k == 0) return 0;  
        k = ... k+1;  
    }  
  
    return 1;  
}
```

Interrupts must save the processor state

Interrupt handlers can be ordinary subroutines

```
void uart_handler(void) {  
    if (UART.TXDRDY) {  
        // send another char  
    }  
}
```

[11.2] Interrupt entry

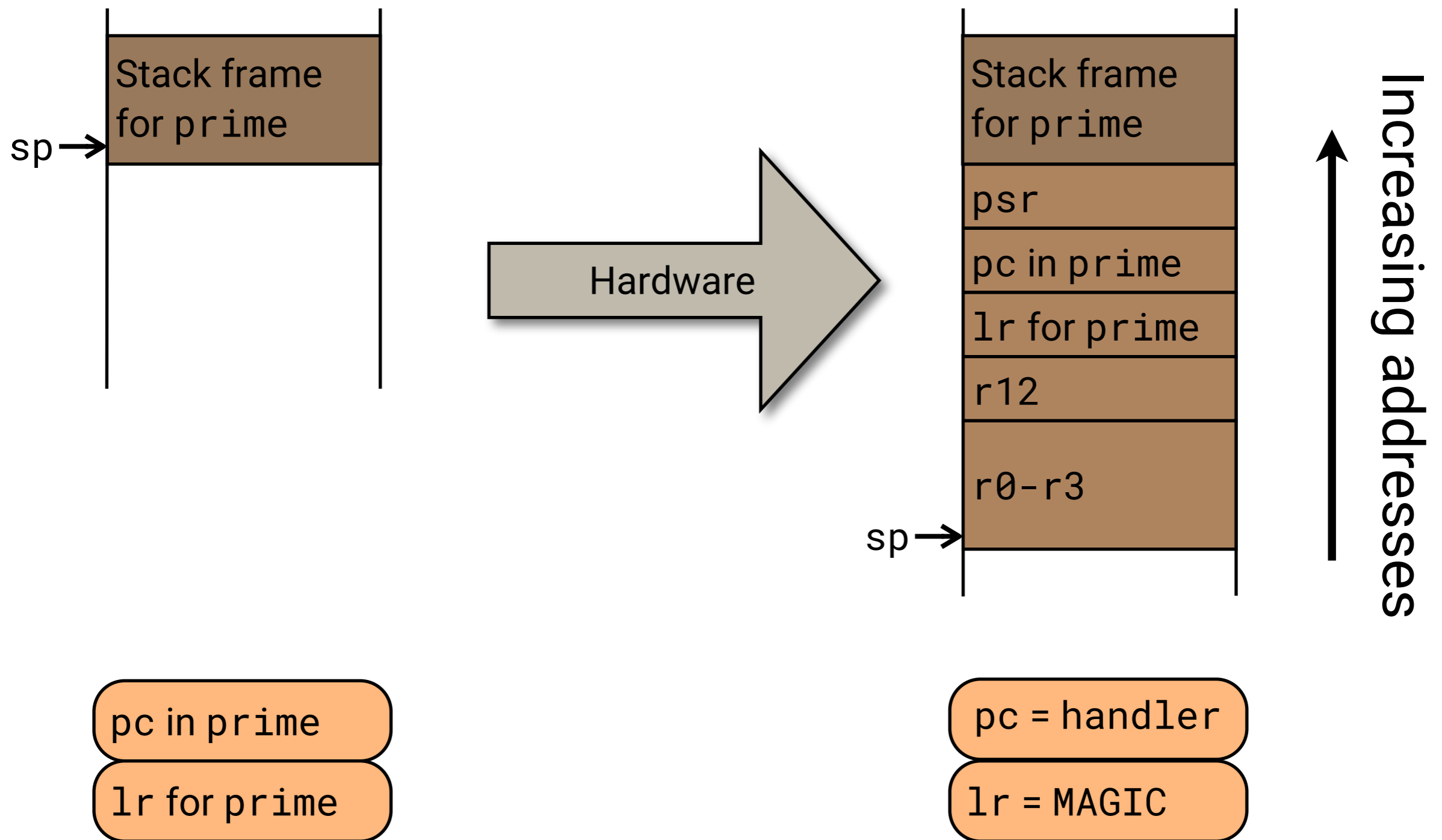

[11.3] Entering handler

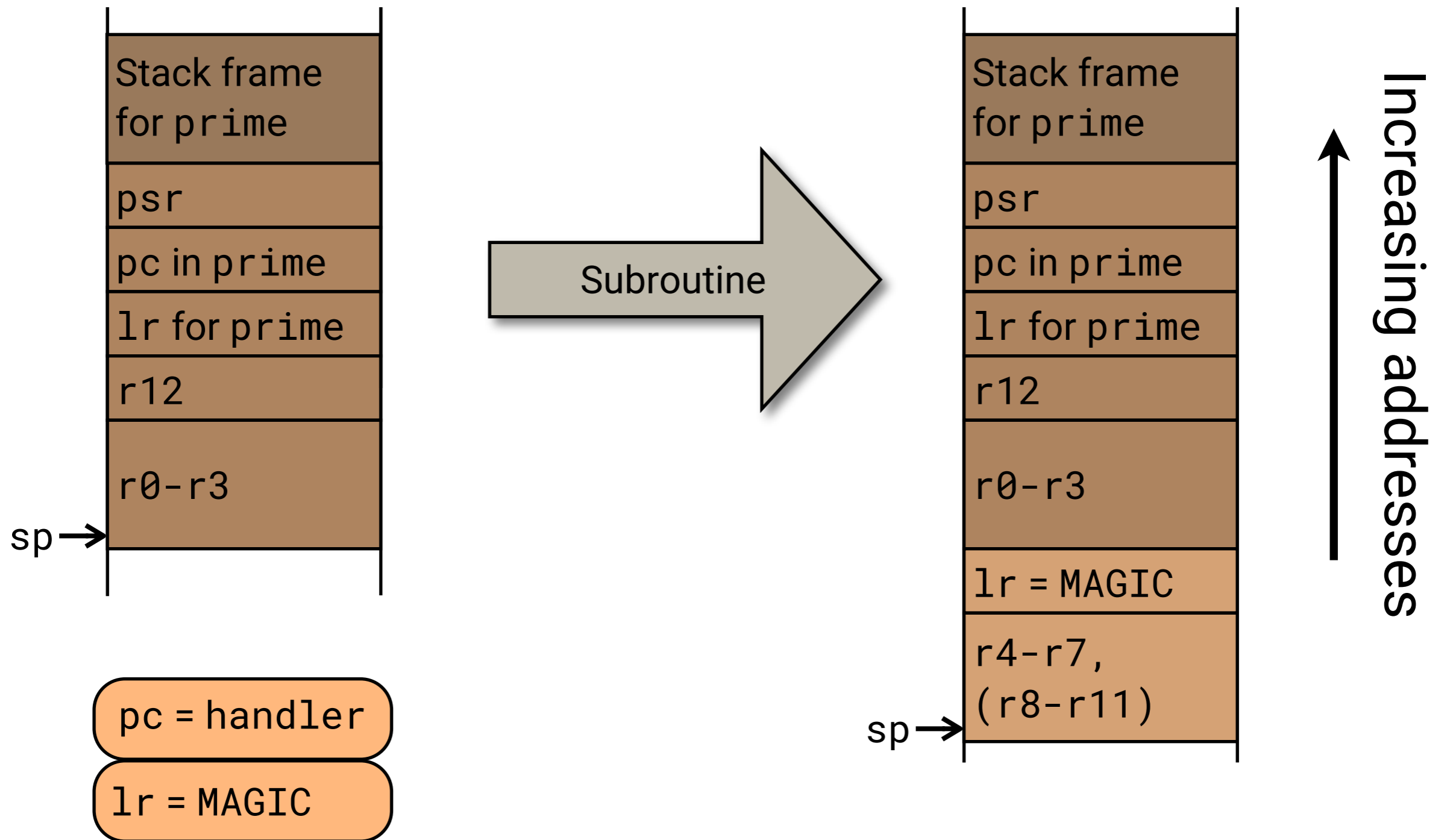

[11.4] Exiting handler

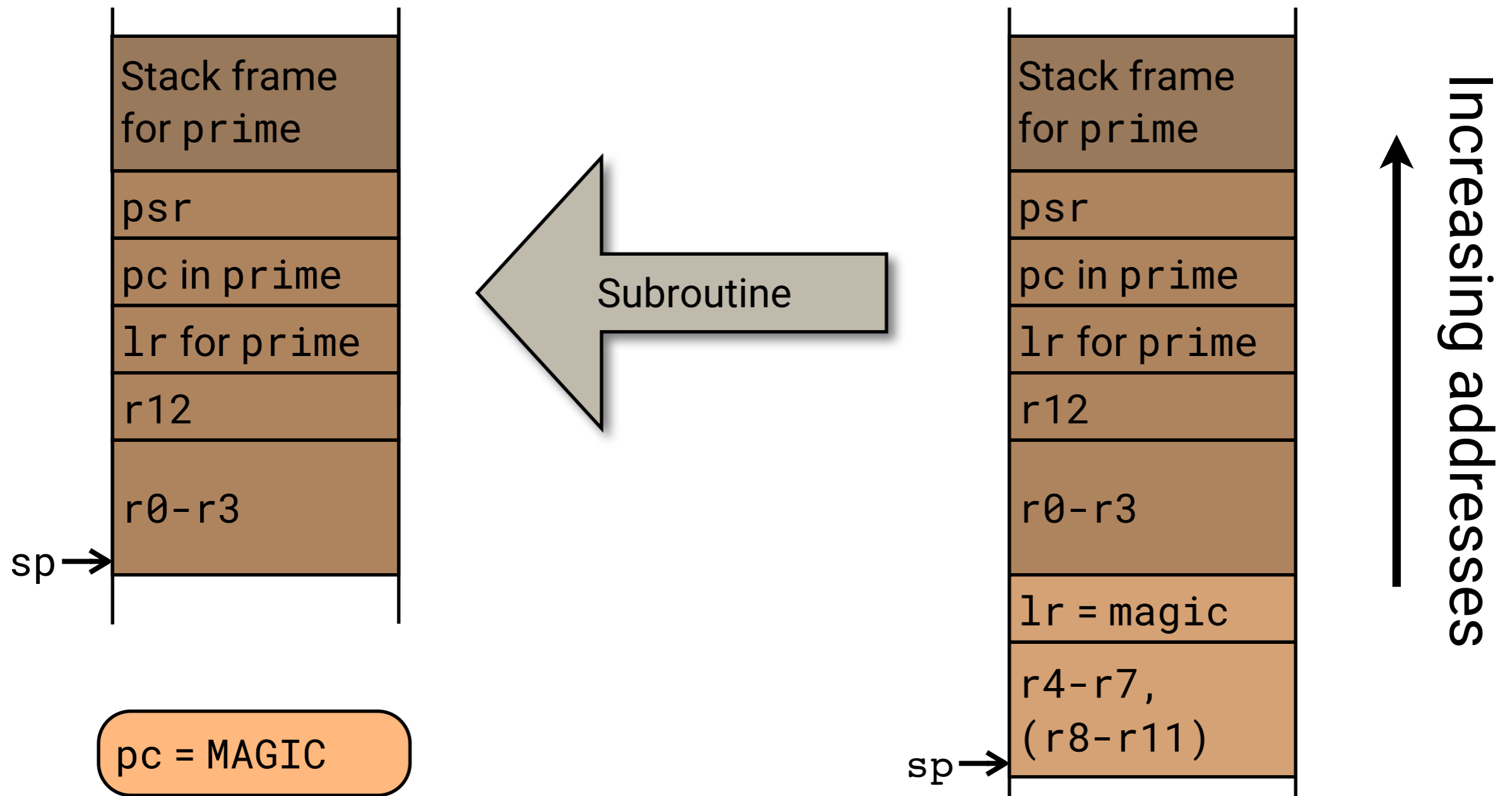

[11.5] Interrupt exit

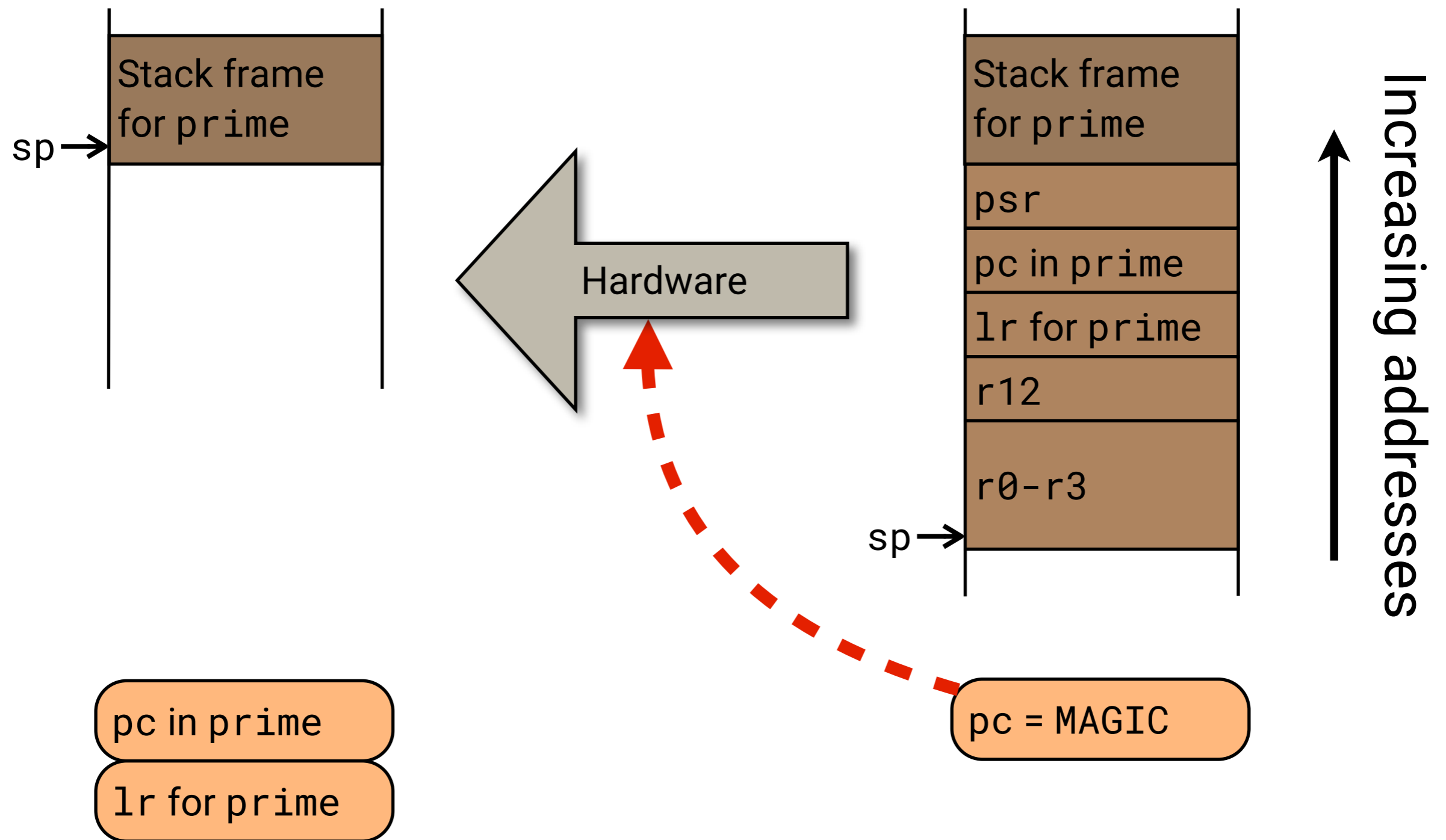

[11.6] Scheduling regular actions

Version 0: delay loops (already seen).

- *Wasteful of time and power.*

Version 1: use a timer for delays (this lecture).

- *Still wastes time.*

Version 2: purely interrupt driven (this lecture).

- *Efficient but inflexible.*

Version 3: use an operating system (next time).

- *Best of all worlds!*

[11.7] Timer hardware

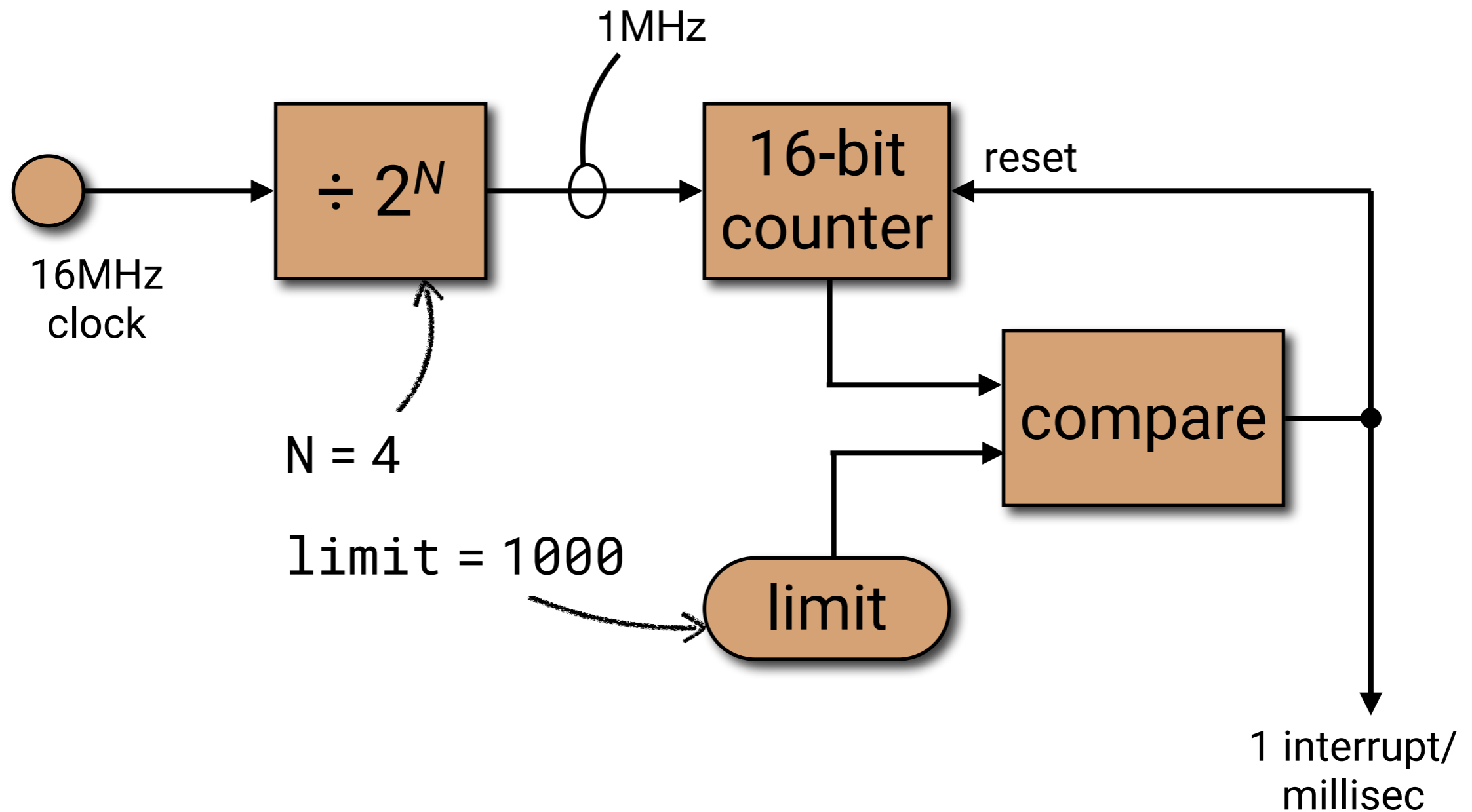

[11.8] Reimplementing delay()

```
unsigned volatile millis = 0;
```

```
void timer1_handler(void) {  
    if (TIMER1.COMPARE[0]) {  
        millis++;  
        TIMER1.COMPARE[0] = 0;  
    }  
}
```

```
void delay(unsigned usec) {  
    unsigned goal = millis + usec/1000;  
    while (millis < goal) {  
        pause();  
    }  
}
```



Uses wfe instruction

[11.9] Idea 2: interrupt driven

Make timer_interrupt call this at 5ms intervals:

```
static int row = 0;

void advance(void) {
    row++;
    if (row == 3) row = 0;
    GPIO.OUT = heart[row];
}
```

- No internal control structure allowed.
- Efficient but inflexible.